

2021-02-25

REQUEST FOR QUOTATION
BUILDING ENVELOPE REHABILITATION AT AMERICAS
PAVILION – BELVEDERE ROOF AND INTERIOR
TZC T 05-2021-02
ADDENDUM #3

This addendum shall be incorporated into, and form part of TZC T 05-2021-02 and take precedence over all requirements of the previously issued bid documents including plans. This addendum must be signed by the bidder (signing officer) in the appropriate space and must be attached to the Form for submission by the bidder. This Addendum consists of four (4) pages.

1. SUBMISSION DEADLINE:

Revised Submission Deadline: **Wednesday, 2021-03-10 at 12:00 p.m. local time**

2. ADD DRAWINGS:

SHEET NUMBER	SHEET NAME	ISSUE DATE
D6 – REV 01	THROUGH SLAB CONCRETE REPAIRS	2021-02-25

3. ADD:

PART 3 – DRAWINGS AND SPECIFICATIONS

SPECIFICATIONS/SCOPE:

SECTION NUMBER	SHEET NAME	ISSUE DATE
287332	PINCHIN - INVESTIGATION OF MOULD GROWTH – OTTER VIEWING AREA	2021-02-19

4. ADD:

PART 3 – SCOPE – 1.0 SCOPE OF WORK

10. Supply all labour, tools, materials and equipment to complete the **removal and disposal of hazardous building materials** at the OTTER VIEWING AREA as outlined in the documents, drawings and specifications.
 - (a) Drawings and specifications to include:
 - (i) PINCHIN – INVESTIGATION OF MOULD GROWTH – OTTER VIEWING AREA

5. DELETE:

PART 5 – PRICING FORMS (2021-02-03), Issued: 2021-02-10 per Addendum 1

ADD:

PART 5 – PRICING FORMS (2021-02-25), Issued: 2021-02-25 per Addendum 3

6. CORRIGENDUM:

SECTION 01 11 00, CLAUSE 1.7 (CORRIGENDUM)

Delete “hot applied rubberized asphalt” and replace with “Mel-Dek Bridge membrane from W.R. Meadows” including the following Accessories:

- Mel-Dek Bridge Membrane
- Mel- Prime (Type Suitable for ambient Condition)
- Detail Strip
- Pointing Mastic
- Joint Sealant shall be Deck-O-Seal 125 by W. R meadows and shall replace Hot Poured Sealer as indicated in detail drawing #'s 2/D2 , 3/D2 , 4/D2 and 5/D2.
- Stainless steel Fastening bar with Caulking Lip along the top free edge and stainless steel 316 grade fasteners to secure Mel-Dek Flashing Membrane along vertical upturns.

All exposed concrete curbs within work area, where membrane is terminated at asphalt finish grade, shall be covered by Vulkem 350/351 along the front, top and back surface below the level of structural slab.

7. CLARIFICATION:

DRAWING S01, RAILING

The following is clarification pertaining to glass infill serving as balustrade for guard rail, and the requirements:

1. Glass Balustrade shall be fabricated using Tempered Glass.
2. Thickness of Glass Balustrade shall be designed by professional engineer responsible for providing the guard Rail stamped shop drawings.
3. The design of railing and glass infill shall satisfy the requirements of applied loading as depicted in Drawing S01.
4. Tempered glass shall withstand thermal stresses under differential temperature of +/- 30 degrees Celsius.
5. Glass shall be warrantied for period of ten (10) years for any breakage caused by thermal stresses under standard weather conditions prevalent in the City of Toronto and by normal human body impact.

8. Question:

Do the subtrades need to be union?

Answer:

No. Fair Wage Policy is applicable.

9. Question:

Does Toronto Zoo has union agreement?

If yes, than please provide the name of unions so that we can price accordingly for the subject noted project

Answer:

No. Fair Wage Policy is applicable.

10. Question:

Regarding the Bid Bond & Agreement to Bond, are we required to submit hard copies to the zoo prior to closing, or will the electronic version be acceptable with the bid submission?

Answer:

Submit all documentation including Bid Bond and Agreement to Bond with your electronic submission.

11. Question:

For the Performance Bond & Labour/Material Bond on page 19, Item #2.3.2.2, (and on page 119 Item #8.2.1) it states that these documents will be supplied by the “Successful Supplier” and that these documents will be sent prior to the Commencement Date of the project – however the Performance Bond & Labour/Material Bond are listed as the last 2 documents of the Submission Form on page 7, item #1.3.1 (under Part 4)

Could you please clarify that only the Successful Supplier is needed to submit the Performance Bond & Labour/Material Bond, and that these items will not be needed at time of submission?

Answer:

The Performance Bond & Labour/Material Bond noted on the Submission Form on page 7, item#1.3.1 (under Part 4) are only required by the Successful Bidder.

12. DELETE:

BID DOCUMENTS AND SPECIFICATIONS – PART 1 – GENERAL – 1.11 SCOPE OF WORK: INTERIOR FINISHES

12.11 SCOPE OF WORK: INTERIOR FINISHES

.1 Tender item 8.1 is for costs related to supply and installation of new rigid insulation, blocking, and wood finishes matching the existing in materials and colour. Existing artificial rockwork must be protected during the interior repair work. Any damage to the existing artificial rockwork must be repaired with no cost to the owner.

ADD:

BID DOCUMENTS AND SPECIFICATIONS – PART 1 – GENERAL – 1.11 SCOPE OF WORK: INTERIOR FINISHES

1.11 SCOPE OF WORK: INTERIOR FINISHES

.1 Tender item 8.1 is for costs related to supply and installation of new rigid insulation, blocking, and wood finishes matching the existing in materials and colour. Existing artificial rockwork must be protected during the interior repair work. Any damage to the existing artificial rockwork must be repaired with no cost to the owner, by a Rockwork Contractor.

The Rockwork Contractor shall meet the following minimum requirements, and provide the following prior to repairs:

- a. A signed statement of experience certifying that the Contractor is an established business with a minimum of 5 years of experience and indicate in detail their experience in successfully constructing artificial rockwork.
- b. Photographic proof and reference material for evaluation of experience and ability to perform under this Work, including at least five colour photographs of previous comparable work to show the Contractor's capabilities to construct artificial geology and landform including mud, rocks, and trees.
- c. Contractor also to include a list of completed projects and references which demonstrate these capabilities. These projects and photographs of projects must have been the work of those craftsmen and artists proposed for this work.
- d. Full documentation of the Construction crew, including resumes of lead personnel (onsite supervisor, and final texturing and finish experts, et al) lists of specific personnel to be used, and details of each listed person's experience and abilities to perform all phases of construction under this Work to the Owner's satisfaction. The assigned project on site supervisor and aesthetic coordinator's resume should show a minimum of five (5) years of experience in the management of project crews of no less than five persons, as well as experience in coordination with other trades in the completion of simulated exhibitry fabrication projects under the Work.

The Toronto Zoo reserves the right to reject non-qualified subcontractors, based on qualification submittals and, at their option, review of past work and references.

Rockwork is to be a realistic representation of actual environments and similar quality detail as existing, or other Toronto Zoo exhibit rockwork.

Receipt of the Addendum shall be acknowledged as part of your submission.

The Board of Management of the Toronto Zoo reserves the right to reject any or all Tenders or to accept any quotation, should it deem such action to be in its interests.

If you have any queries regarding this matter, please contact Mr. Peter Vasilopoulos, Supervisor, Purchasing & Supply, at 416-392-5916 or by email pvasilopoulos@torontozoo.ca.

Yours truly,

Peter Vasilopoulos
Supervisor, Purchasing & Supply

I/we hereby acknowledge receipt of this addendum and make allowance in my bid.

Signed (Must be Signing Officer of Firm)

Name of Firm

Date:



2021-02-25

TZC T 05-2021-02 BUILDING ENVELOPE REHABILITATION AT AMERICAS PAVILION – BELVEDERE ROOF AND INTERIOR PART 5– PRICING FORMS

Tender Pricing Form Submission

Complete and return this section Part 4–*Form of Tender* including Appendices I to XII

Project/Contract: BUILDING ENVELOPE REHABILITATION AT AMERICAS PAVILION – BELVEDERE ROOF AND INTERIOR

Project/Contract No.: TZC T 05-2021-02

OWNER: TORONTO ZOO

I/We, the undersigned have received, allowed for and included as part of our submission all issued Addendum numbered _____.

This form must be completed, properly signed and received on or before the date and time specified or your submission will not be considered. Quoted prices shall remain in effect for a period of ninety (90) days from the stipulated closing date.

The Board of Management of the Toronto Zoo reserves the right to reject any or all Quotations or to accept any Quotation, should it deem such action to be in its interests.

By signing and submitting this FORM, you are agreeing to the release of your quotation information, as deemed necessary by the Board, in order to conduct business associated with this quotation or project.

I/We, the undersigned, **having the authority to bind the Company**, certify, that I/we have examined the Instruction to Bidders, Construction Agreement and General Conditions, Specifications, Scope of Work, Drawings and Form of Tender, do hereby offer and agree to enter into an agreement with The Toronto Zoo, to REHABILITATE THE BUILDING EVELOPE AT AMERICAS PAVILION – BEVEDERE ROOF AND INTERIOR as described herein for a Total Tender Price, including HST in Canadian funds, equal to the total of the amounts in the following clauses (A) to (B).

THIS TENDER is submitted by

PLEASE
USE INK9999

Name of Firm

Address

Postal Code



2021-02-25

**TZC T 05-2021-02 BUILDING ENVELOPE REHABILITATION AT AMERICAS PAVILION –
BELVEDERE ROOF AND INTERIOR
PART 5– PRICING FORMS**

Telephone Number

Fax Number

Name of Authorized Signing Officer for Firm

Title of Authorized Signing Officer for Firm

Name and Title of Project Contact Person

Email and fax # of Project Contact person

**TZC T 05-2021-02 BUILDING ENVELOPE REHABILITATION AT AMERICAS
PAVILION – BELVEDERE ROOF AND INTERIOR
PART 5– PRICING FORMS**

FORM OF TOTAL TENDER PRICE

(A) PRICE of TENDER, which excludes HST is:

_____ In lawful money of Canada. (State in writing)

\$ _____
(State in numbers)

**(B) PRICE of HST of (13 %) payable by the Owner to the Contractor
DOLLARS**

_____ In lawful money of Canada. (State in writing)

\$ _____
(State in numbers)

**TOTAL TENDER PRICE, which includes the Tender (A) and HST (B) price is:
DOLLARS**

_____ In lawful money of Canada. (State in writing)

\$ _____
(State in numbers)

DISCOUNT	Discount and/or Other	Days
Discount allowed for prompt payment and period within which invoice must be paid to qualify.	%	
Charity Status: The Toronto Zoo is a registered charitable organization (registration #BN 119216398RR0001) and accordingly may be eligible for preferred pricing which should be reflected in the Quotation as submitted.		

**TZC T 05-2021-02 BUILDING ENVELOPE REHABILITATION AT AMERICAS
PAVILION – BELVEDERE ROOF AND INTERIOR
PART 5– PRICING FORMS**

The following appendix(s) must be completed and returned with the tender submission. (“Not applicable” indicated where completion of a section is not required.)

Appendix I	Schedule of Values
Appendix II	Unit Prices
Appendix III	Additional Prices
Appendix IV	Alternative Prices
Appendix V	Unsolicited Prices

**TZC T 05-2021-02 BUILDING ENVELOPE REHABILITATION AT AMERICAS
PAVILION – BELVEDERE ROOF AND INTERIOR
PART 5– PRICING FORMS**

APPENDIX I- SCHEDULE OF VALUES (Due 24 hours after stipulated closing date)

(**included** in Total Tender Price)

All prices are to include the supply and installation of all labour, material, taxes (excluding Harmonized Sales Tax), charges, payroll, burden, and profit, and would be deducted from the Tender Tender Price should the specified work be excluded from the contract work.

ITEM	DESCRIPTION	PRICE
1.	General Items	
1.1.	Provide all General Conditions, including Contractor’s insurance coverage, mobilization, site protection, demobilization and clean-up, labour and project coordination to complete work as specified.	\$
1.2.	Allowance for Permits	\$ 2,000.00
1.3.	Allowance for Testing	\$ 2,000.00
1.4.	Bonds	\$
2.	Exterior Removals	
2.1.	Remove existing asphalt layers to expose existing concrete slab at the road and observation deck.	\$
2.2.	Remove metal flashing and guardrail at the observation deck.	\$
3.	Interior Removals	
3.1.	Remove existing interior finishes to expose existing substrate, under the observation deck.	\$
3.2.	Removal and Disposal of Hazardous Building Materials at the OTTER VIEWING AREA	\$

**TZC T 05-2021-02 BUILDING ENVELOPE REHABILITATION AT AMERICAS
PAVILION – BELVEDERE ROOF AND INTERIOR
PART 5– PRICING FORMS**

4.	Waterproofing	
4.1.	Installation of new waterproof system at the exposed concrete slabs.	\$
5.	Concrete	
5.1.	Installation of new concrete curb on the perimeter of the observation deck.	\$
6.	Asphalt Pavement	
6.1.	Supply, place and compact 50 mm minimum of HL8 (HS) Base Course Asphalt at the road section and observation deck.	\$
6.2.	Supply, place and compact 50 mm minimum of HL3 (HS) Top Course Asphalt at the road section and observation deck.	\$
7.	Metal Railing	
7.1.	Installation of new metal railing complete with safety glass.	\$
8.	Interior Finishes	
8.1.	Installation of new interior finishes to match the existing.	\$
		<hr/>
	Total Bulk Tender Price*	\$
		<hr/> <hr/>

**TZC T 05-2021-02 BUILDING ENVELOPE REHABILITATION AT AMERICAS
PAVILION – BELVEDERE ROOF AND INTERIOR
PART 5– PRICING FORMS**

*The sum of the amounts shown in the table above **should** equal the Total Tender Price stipulated in the space provided in the Form of Total Tender Price

**TZC T 05-2021-02 BUILDING ENVELOPE REHABILITATION AT AMERICAS
PAVILION – BELVEDERE ROOF AND INTERIOR
PART 5– PRICING FORMS**

APPENDIX II - UNIT PRICES (Due 24 hours after stipulated closing date)

All prices are to include the supply and installation of all labour, material, charges, taxes (excluding Harmonized Sales Tax), payroll, burden and profit.

ITEM	UNIT	ADD	DEDUCT
Foreman	/hr		
Tradesman	/hr		
Labourer	/hr		
Asphalt Replacement	/sqm		
Expose and Prepare (CSP-4) road concrete slab for new waterproofing system	/sqm		
Waterproofing	/sqm		
Guardrail System	/l.m		
Perimeter Sealant (DYMONIC 100 by Tremco)	/l.m		
Prepare concrete to CSP-4 as per ICRI and apply new waterproofing system Vulkem 350/351 by Tremco	/sqm		

**TZC T 05-2021-02 BUILDING ENVELOPE REHABILITATION AT AMERICAS
PAVILION – BELVEDERE ROOF AND INTERIOR
PART 5– PRICING FORMS**

APPENDIX III - ADDITIONAL PRICES (Due 24 hours after stipulated closing date)

(not included in Total Tender Price)

All prices are to include the supply and installation of all labour, material, taxes (excluding Harmonized Sales Tax), charges, payroll, burden and profit.

ITEM	DESCRIPTION	PRICE
	Top Surface Concrete Repairs (As per Detail D3) up to 75mm depth. Quantity = 2 sqm.	\$ _____/sqm Increase / Reduction
	Through Slab Concrete Repairs (As per Detail D5). Quantity = 2sqm.	\$ _____/sqm Increase / Reduction
	Soffit Concrete Repairs (As per Detail D4) up to 50mm depth. Quantity = 2sqm.	\$ _____/sqm Increase / Reduction
	Slab Edge Concrete Repairs (As per Detail D6) Full slab depth and up to 150mm deep. Quantity = 6m.	\$ _____/m Increase / Reduction

* For each item, insert amount in the appropriate column to indicate whether the price change will result in an increase in, or a reduction of, the Total Tender Price.

* Shoring shall be provided along the underside as per engineered shop drawings to be provided by the prospective Contractor who will be qualified for the renovation project in question.

**TZC T 05-2021-02 BUILDING ENVELOPE REHABILITATION AT AMERICAS
PAVILION – BELVEDERE ROOF AND INTERIOR
PART 5– PRICING FORMS**

APPENDIX IV- ALTERNATIVE PRICES (Due 24 hours after stipulated closing date)

(**not included** in Total Tender Price)

All prices are to include the supply and installation of all labour, material, taxes (excluding Harmonized Sales Tax), charges, payroll, burden and profit.

Item	Description	Increase or Reduction From Total Tender Price
-------------	--------------------	--

1.	Insert description of alternative	\$
----	-----------------------------------	----

2.	Insert description of alternative.	\$
----	------------------------------------	----

* For each item, insert amount in the appropriate column to indicate whether the price change will result in an increase in, or a reduction of, the Total Tender Price.

**TZC T 05-2021-02 BUILDING ENVELOPE REHABILITATION AT AMERICAS
PAVILION – BELVEDERE ROOF AND INTERIOR
PART 5– PRICING FORMS**

APPENDIX V - *UNSOLICITED ALTERNATIVES (Due 24 hours after stipulated closing date IF APPLICABLE)
(prices not used for Total Tender Price)

All alternatives must conform to the requirements of Section 01 25 00 – Product Substitution Procedures.

All prices are to include the supply and installation of all labour, material, taxes (including Harmonized Sales Tax), charges, payroll, burden and profit.

Number of Item	Description of Item	Change in Total Tender Price Substituted in Work	
		Increase	Reduction

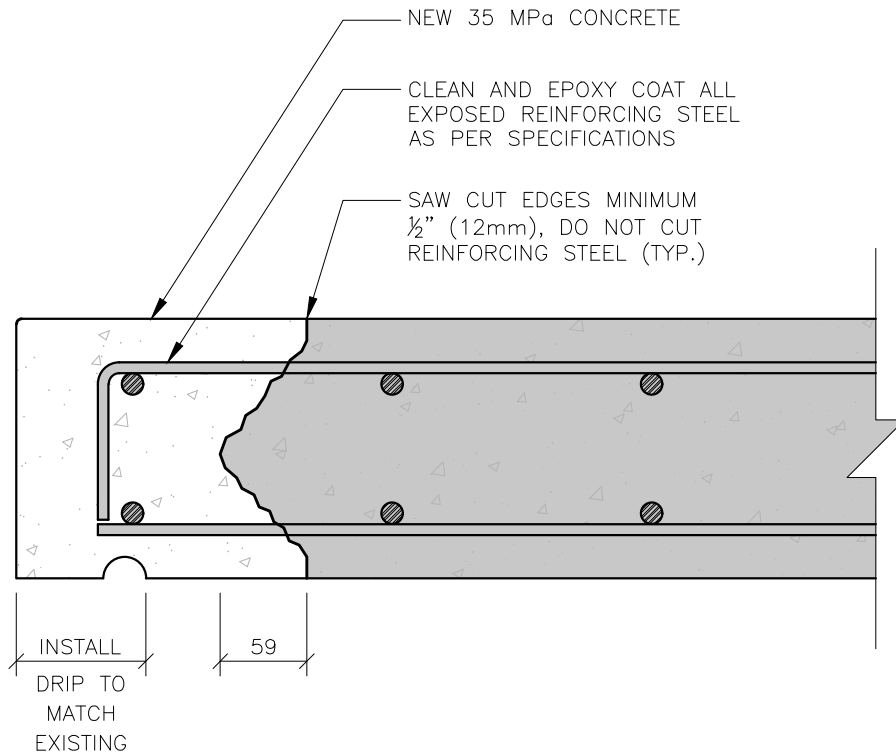

NOTES:

1. REFER TO SPECIFICATIONS FOR DETAILS.
2. PROVIDE A MINIMUM 1" (25mm) CLEARANCE BETWEEN EXPOSED REINFORCING STEEL AND EXISTING CONCRETE. MAINTAIN A MINIMUM 10mm COVER FOR ALL REINFORCING STEEL (EXISTING AND NEW).
3. PRIOR TO PLACING NEW CONCRETE, APPLY A CONCRETE BONDING AGENT TO ALL EXISTING CONCRETE SURFACES IN CONTACT WITH NEW CONCRETE.
4. WHERE REQUIRED, PROVIDE ONLY NEW PLYWOOD SHEATHING FOR ALL EXPOSED SURFACES.
5. WHERE REQUIRED, PROVIDE SHORING DESIGN AND REVIEW INCLUDING A SITE VISIT REPORT BY A SHORING ENGINEER PRIOR TO COMMENCING CONCRETE REMOVALS.



TITLE: THROUGH SLAB CONCRETE REPAIRS
 CLIENT: TORONTO ZOO
 PROJECT: ASPHALT & OBSERVATION DECK REHABILITATION
 316A OLD FINCH AVENUE
 TORONTO, ONTARIO

IRC #: 10978
 W.O.#: HR19-084SP
 DRN.: H.V.
 CHK.: C.T.

SCALE: AS NOTED
 DATE: 2019/08/16
 DWG.#: D6
 REV.#: REV01



Investigation of Mould Growth

Toronto Zoo
361A Old Finch Avenue, Toronto, Ontario

Prepared for:

Toronto Zoo
361A Old Finch Avenue
Toronto, Ontario, M1B 5K7

February 19, 2021

Pinchin File: 287332



Issued to: Toronto Zoo
Issued on: February 19, 2021
Pinchin File: 287332
Issuing Office: Mississauga, ON

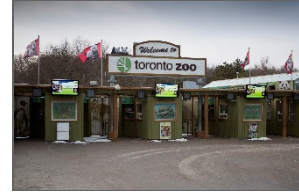

Author: Elizabeth Kennedy, BSc. Hon
Project Technologist
416.417.8513
ekennedy@pinchin.com

Reviewer: Mughis Syed, P.Eng., M.Env.Sc., PMP
Senior Project Manager
905.363.1448
msyed@pinchin.com

Reviewer: David Muise, OHST
National Practice Leader
902.461.9999
dmuise@pinchin.com



EXECUTIVE SUMMARY

Toronto Zoo retained Pinchin Ltd. (Pinchin) to perform an investigation of potential mould growth in the Africa Restaurant, the Otter Viewing Area and the Beaver/Otter Pump Room at Toronto Zoo located at 361A Old Finch Avenue, Toronto, Ontario following identification of water damage and possible mould growth. The investigation, conducted on February 8, 2021 addressed the basement of the Africa Restaurant, Otter Viewing Area and the Beaver/Otter Pump Room and included interviews, inspections, and testing.

Pinchin identified the following during the investigation

- **Basement of African Restaurant:**
 - Mould growth on the eroded and wet concrete ceiling above the Walk-in Cooler, some rebar were exposed and rusty where concrete ceiling was eroded.
 - Mouldy drywall ceiling along the east wall in the Staff Room
 - Mouldy and water damaged pipe insulation in the Drinking Fountain area and in the ceiling space of the Staff Room.
 - Mouldy/water damaged/wet ceiling tiles at several locations in the Staff Room and Office Space.
 - One missing ceiling tile in Office Space.
- **Otter Viewing Area:**
 - Mould growth and water damage on wooden ceiling and bulkhead wall finishes along the south wall.
 - Water stained foam insulation on the ceiling at northwest corner and bulkhead along south wall.
 - Elevated moisture content was measured on concrete floor near northwest corner.
- **Beaver/Otter Pump Room:**
 - Mouldy and water damaged insulation on most of the pipes and pipe fittings.

The water damage and mould growth identified on the concrete ceiling above Walk-in Cooler in the Basement of the African Restaurant is likely caused by the leak and/or condensation/moisture from the refrigeration and freezer units present above on the Main Floor. The cause of the water damage in the staff room ceiling space and Drinking Fountain area in the Basement of the African Restaurant could not be identified. The likely cause of water damage and mould growth identified in the Otter Viewing Area is



ongoing roof leaks in the Otter Viewing Area. The water damage and mould growth identified on pipe insulations in the Beaver/Otter Pump Room is likely caused by condensation of the pipes and/or spray from the pumps and elevated humidity in the room. Further investigation of water damage and necessary repairs in these areas is recommended. Pinchin's Building Science Group would be pleased to assist with this work, if required.

As per the lab results, insulation on the pipe fittings in the Africa Restaurant and Beaver/Otter Pump Room contain asbestos. Based on the age of the building (1970), the drywall joint compound on the drywall ceiling of Staff Room, skim coat on concrete ceiling and ceiling tiles in the Africa Restaurant should be considered asbestos-containing until proven otherwise by sampling.

The following recommendations are offered to improve air quality in this building:

1. Communicate the findings of this report as necessary.
2. Retain a building science professional to perform further investigation into the source of the water damage and make repairs as required. Pinchin's Building Science Group would be pleased to assist with this work, if required.
3. Arrange for the preparation of a detailed Scope of Work for the mould remediation including any required asbestos precautions and finalize an inspection and oversight plan.
4. Perform the following in the Basement of African Restaurant as outlined on drawing 1:
 - a. Following EACO Level 2 mould procedures in conjunction with O.Reg 278/05 Type 2 asbestos procedures clean mould growth on the concrete ceiling above the Walk-in Cooler.
 - b. Following EACO Level 2 mould procedures in conjunction with O.Reg 278/05 Type 2 asbestos procedures remove and dispose of mouldy/water damaged drywall ceiling in the Staff Room one foot past any mouldy and /or water damaged conditions.
 - c. Following Level 2 mould procedures in conjunction with O.Reg 278/05 Type 2 asbestos glove bag procedures remove and dispose of mouldy and water damaged pipe insulation in the Drinking Fountain area and in the ceiling space of the Staff Room.
 - d. Following EACO Level 1 mould procedures in conjunction with O.Reg 278/05 Type 1 asbestos procedures remove and dispose of mouldy/water damaged/wet ceiling in the Staff Room and Office Space.



5. Following Level 2 mould procedures perform the following in the Otter Viewing Area as outlined in drawing 3:
 - a. Clean mould growth with wire brush on the wood ceiling and wall finishes. Dispose of uncleanable part of the ceiling and wall finishes.
 - b. Remove and dispose of stained foam insulation on the ceiling northwest corner and bulkhead along south wall.
6. Following Level 2 mould procedures in conjunction with Type 3 asbestos procedures remove and dispose of mouldy and water damaged insulation on the pipes and pipe fittings in the Beaver/ Otter Pump Room as outlined on drawing 2.
7. Finalize an inspection and testing plan to document the mould remediation. To confirm, Pinchin would perform inspections at the following stages:
 - a. Clean Site Preparation
 - b. Post-Remediation Inspection
 - c. Post-Remediation Air Sampling
8. Clean the floors, other building surfaces, furnishings and contents in areas immediately adjacent to the remediation work area(s), following normal custodial practices.
9. Implement drying procedures as necessary. Ensure all surfaces are dry before installation of new finishes.



TABLE OF CONTENTS

1.0	INTRODUCTION AND SCOPE	1
1.1	Statement of Understanding	1
1.2	Scope of Work	1
2.0	METHODOLOGY	1
2.1	Interviews and Inspections	1
2.2	Test Methods and Criteria	2
2.3	Laboratory Analysis	3
3.0	FINDINGS	3
3.1	Results of Interviews	3
3.2	Facility Description.....	4
3.3	Results of Inspections and Testing.....	4
3.4	Summary of Hazardous Materials	7
3.4.1	Asbestos.....	8
3.4.2	Lead.....	8
3.4.3	Silica	8
3.4.4	Mercury.....	8
3.4.5	Polychlorinated Biphenyls	8
4.0	DISCUSSION	8
4.1	Discussion of Water Damage and Mould Growth	8
4.2	Mould Remediation and Inspection	9
4.3	Communication and Interim Risk Management	10
5.0	RECOMMENDATIONS.....	10
6.0	TERMS AND LIMITATIONS	11



APPENDICES

APPENDIX I	Drawing
APPENDIX II	Results of Mould Samples
APPENDIX III	Results of Asbestos and Lead Samples

LIST OF TABLES

Table I – Parameters Tested, Recommended Limits and Instruments or Methods Used	2
Table II – Facility Description	4
Table III – African Restaurant Basement	4
Table IV – Otter Viewing Area	6
Table V – Beaver / Otter Pump Room	6
Table VI – Outdoors	7



1.0 INTRODUCTION AND SCOPE

1.1 Statement of Understanding

Pinchin Ltd. (Pinchin) was retained by Toronto Zoo (Client) to conduct an investigation of potential mould growth in the Africa Restaurant, the Otter Viewing Area and the Beaver/Otter Pump Room at Toronto Zoo located at 361A Old Finch Avenue, Toronto, Ontario. The investigation was conducted following the identification of potential mould growth in these areas.

1.2 Scope of Work

Pinchin performed the investigation on February 8, 2021. The scope of this investigation was limited to the Basement of African Restaurant, the Otter Viewing Area and the Beaver/Otter Pump Room.

The investigation involved the following activities:

- Review of occupant and management concerns.
- Spot readings of moisture content of building materials.
- Walkthrough inspection for water damage or mould growth.
- Collection and analysis of the following (including reference and field blanks):
 - Seven mould bulk and/or tape-lift samples.
 - Three samples to test for asbestos in bulk materials.
 - One bulk sample to test for lead in paint.

2.0 METHODOLOGY

2.1 Interviews and Inspections

Pinchin interviewed building staff to discuss the history of the building, maintenance practices, water damage and any indoor air quality complaints.

Pinchin performed a walkthrough inspection for indications of suspect mould growth and/or water damage on accessible building materials, paying particular attention to areas where past water damage had been reported.

The investigator did not perform any destructive work to inspect concealed conditions inside wall and/or ceiling cavities.

The investigator used a moisture meter to test for elevated moisture levels in building materials.

Pinchin identified suspect hazardous building materials within the area of expected water damage and/or mould remediation. The assessment will provide sufficient detail to allow for the removal and replacement of these materials using appropriate precautions to facilitate repair of the building. This assessment does not provide sufficient detail for long term management of hazardous materials as required by Health and Safety regulations.

2.2 Test Methods and Criteria

The following table presents the parameters tested in this investigation, recommended limits or interpretation guides, the units of measurement, and the instruments and sampling/analytical methods employed.

Table I – Parameters Tested, Recommended Limits and Instruments or Methods Used

Parameter	Unit of Measurement	Recommended Limit or Guide to Interpretation	Instrumentation or Test Method
Temperature, T	°C	Consider the risk of condensation on cold surfaces to prevent mould growth	Digital Psychrometer 8760
Relative Humidity, RH	%RH	Maintain long term below 80 %, to prevent mould growth ¹	Extech® Precision Psychrometer RH390
Moisture in building materials (Note: detects surface moisture only, may not detect deeper moisture)	% Moisture	Threshold for mould growth: ² Drywall, 0.7% Wood materials, 17%	Protimeter® Surveymaster System Delmhorst® BD-2100
Mould in bulk, tape-lift samples (DME)	Presence or absence of Mould Growth, to genus, and Light, Moderate or Heavy density ³	Current guidelines recommend remediation of all interior mould growth, regardless of species	Direct Microscope Examination with staining
Asbestos in bulk materials	% Asbestos	Threshold for mandatory precautions set in provincial regulations	Polarized Light Microscopy, dispersion staining

1 O.A.G. Adan, R.A. Samson (Editors): *Fundamentals of Mold Growth in Indoor Environments and Strategies for Healthy Living*. Wageningen, The Netherlands: Wageningen Academic Publishers, 2011

2 Macher, J. (Ed): *Bioaerosols, Assessment and Control*. Cincinnati OH: American Conference of Governmental Industrial Hygienists, 1999.

3 The density of mould growth is ranked by the Pinchin Environmental Microbiology Laboratory as: Light (covers less than about 10% of specimen); Moderate (covers 10-20% of specimen); or Heavy (covers more than about 20% of specimen).



Table I – Parameters Tested, Recommended Limits and Instruments or Methods Used

Parameter	Unit of Measurement	Recommended Limit or Guide to Interpretation	Instrumentation or Test Method
Lead in paint	% Lead	Threshold for mandatory precautions set in provincial regulations	Flame Atomic Absorption

2.3 Laboratory Analysis

The analysis for mould was performed at the Pinchin Environmental Microbiology Laboratory, Mississauga. The Pinchin laboratory is independently accredited to ISO/IEC 17025:2017 for mould and bacteria analysis, by the American Industrial Hygiene Association Laboratory Accreditation Program LLC (AIHA LAP LLC) (Lab ID 158835)⁴ and the Quebec government (Lab ID 495).⁵

The asbestos samples were analysed at the Pinchin Ltd. Asbestos Bulk Laboratory, Mississauga, Ontario. The analysis was performed in accordance with US EPA Test Method EPA/600/R-93/116: Method for the Determination of Asbestos in Bulk Building Materials, July 1993. The laboratory is independently accredited for the analysis of asbestos in bulk materials to ISO/IEC 17025/2017.⁶

Analysis for lead in paints or surface coatings is performed at an accredited laboratory in accordance with EPA Method No. 3050B/Method No. 7420; flame atomic absorption.

Pinchin does not perform sampling of materials for silica, mercury, or Polychlorinated Biphenyls (PCBs).

3.0 FINDINGS

3.1 Results of Interviews

Building Staff reported the following:

- Ongoing roof leaks during heavy rains in the Otter Viewing Area for the past at least three months.
- Mouldy pipe insulation in the Beaver/Otter Pump Room was identified by musty odour during recent maintenance.

4 Accredited by the American Industrial Hygiene Association Laboratory Accreditation Program LLC (AIHA LAP LLC) under the Environmental Microbiology Laboratory Accreditation Program (EMLAP), for Bulk, Surface and Air testing for moulds, Escherichia coli, Legionella by the ISO 11731 method and for Legionella pneumophila by qPCR ISO 12869 method (Lab ID 158835).

5 Accredited by the Quebec government under the Programme d'accréditation des laboratoires d'analyses (PALA) program for Air Microbiology – domains 601, 603, 604, 605, 606.

6 Accredited by the US National Voluntary Laboratory Accreditation Program (NVLAP Lab Code 101270-0).

3.2 Facility Description

Table II – Facility Description

Item	Details
Construction Date	1970's
Flooring	Concrete, vinyl floor tile, ceramic tile
Interior Walls	Concrete, wood
Ceilings	Concrete, drywall, lay-in acoustic ceiling tiles, wood

The facility was built at a time when asbestos-containing building materials were commonly used.

3.3 Results of Inspections and Testing

This section presents the findings of the walkthrough investigation and any tests for mould, asbestos or lead. Appendix I presents the drawings. The analytical certificates for the mould tests are given in Appendix II. The results of the asbestos and lead tests are given in Appendix III.

Table III – African Restaurant Basement

Temperature	24.4 °C	Extent of Mould Growth	80 ft ²
Relative Humidity	17.0 %RH	Extent of Water Damage Including Mould Growth	80 ft ²



Photo 1 - Mould growth and eroded concrete ceiling above Walk-in Cooler in the Basement



Photo 2 - Water damaged/mouldy ceiling tiles in the Staff Room

Table III – African Restaurant Basement



Photo 3 - Mouldy pipe insulation in ceiling space in the Staff Room



Photo 4 - Mouldy/water damaged pipe Insulation in Fountain Drink area

Moisture Measurements

Material/Location	Results	Material	Results
Concrete Above Cooler (Dry Reference: 200 - 220)	225 - 325 -- WET	Staff Room Ceiling Tiles	0.9 - 1.1% - WET

Sample Log

Sample Type/ Location	Sample No.	Result
Bulk Mould/ Fountain Drinks Area Pipe Insulation	MB-01	Confirmed Mould Growth
Bulk Mould/ Staff Room Pipe Insulation	MB-02	Confirmed Mould Growth
Mould Tape-Lift/ Concrete ceiling	TL-01	Confirmed Mould Growth
Mould Tape-Lift/ Drinking Fountain Area PVC Pipe	TL-02	Confirmed Mould Growth
Asbestos/ Staff Room, Pipe Parging cement	A0001 A-C	Asbestos Containing
Lead/ Basement, white paint	PA-01	<0.0098%

Observations and Comments

Pinchin identified the following:

- Mould growth on the eroded and wet concrete ceiling above the Walk-in Cooler, and rusty exposed rebars.
- Mouldy drywall ceiling in the Staff Room
- Mouldy and water damaged pipe insulation in the Drinking Fountain area and in the ceiling space of the Staff Room.
- Mouldy/water damaged/wet ceiling tiles at several locations in the Staff Room and Office Space.

Table IV – Otter Viewing Area

Temperature	22.5 °C	Extent of Mould Growth	20 ft ²
Relative Humidity	35.2 %RH	Extent of Water Damage Including Mould Growth	40 ft ²



Photo 5 - Otter Viewing area



Photo 6 - Mouldy/water damaged wood ceiling and bulkhead wall in Otter Viewing area

Moisture Measurements

Material	Results	Material	Results
Concrete Slab (Dry Reference 200 – 250)	650 – 999 -- WET	Wooden wall and ceiling finishes	9.0 – 15.7% -- DRY

Sample Log

Sample Type/Location	Sample No.	Result
Mould Tape-Lift/ Wooden wall finishes	TL-03	Confirmed Mould Growth

Observations and Comments

Pinchin identified the following:

- Water stained foam insulation on the ceiling at northwest corner and bulkhead along south wall.
- Water stained wooden ceiling and wall finishes; the wood finishes were measured dry at the time of assessment.
- Elevated moisture content on concrete floor in northwest corner.

Table V – Beaver / Otter Pump Room

Temperature	24.2 °C	Extent of Mould Growth	40 ft ²
Relative Humidity	50.2 %RH	Extent of Water Damage Including Mould Growth	40 ft ²

Table V – Beaver / Otter Pump Room



Photo 7 - Mouldy/stained pipe insulation in Beaver/Otter Pump Room



Photo 8 - Mouldy/stained pipe insulation in Beaver/Otter Pump Room

Sample Log

Sample Type/ Location	Sample No.	Result
Bulk Mould/ Beaver/Otter Pump Room Pipe insulation	MB-03	Confirmed Mould Growth

Observations and Comments

Pinchin identified the following:

- Mouldy and water damaged pipe insulation; Strong musty odour was noticeable inside and immediately outside the room.

Table VI – Outdoors

Temperature	-10 °C	
Relative Humidity	68 %RH	

Photo 9 - Front Gate of Toronto Zoo

3.4 Summary of Hazardous Materials

Based on sampling and age of the building (1970), the following is a summary of the designated substances, limited to the materials impacted the water damage.



3.4.1 *Asbestos*

As per the lab results, insulation on the pipe fittings in the Africa Restaurant and Beaver/Otter Pump Room contain asbestos. Based on the age of the building (1970), the drywall joint compound on the drywall ceiling of Staff Room, skim coat on concrete ceiling and ceiling tiles in the Africa Restaurant are considered asbestos-containing until proven otherwise by sampling.

3.4.2 *Lead*

No paints in the work area contain sufficient lead to require special precautions.

3.4.3 *Silica*

Materials that could contain silica are not impacted by the remediation work. Crystalline silica is a presumed component of concrete, masonry, mortar, ceramic tiles, grout and plaster.

3.4.4 *Mercury*

Materials that could contain mercury are not impacted by the remediation work.

3.4.5 *Polychlorinated Biphenyls*

Materials that could contain PCBs are not impacted by the remediation work.

4.0 DISCUSSION

4.1 Discussion of Water Damage and Mould Growth

In the Basement of African Restaurant, mould growth was identified on the eroded and wet concrete ceiling above the Walk-in Cooler, rebars were exposed and rusty where concrete ceiling was eroded. Mould was also identified on drywall ceiling in the staff room. Mouldy and water damaged pipe insulation was identified in the Drinking Fountain area and in the ceiling space of the Staff Room. Mouldy/water damaged/wet ceiling tiles were identified at several locations in the Staff Room and Office Space. One ceiling tile was missing in Office Space.

In Otter Viewing Area mould growth and water damage was identified on wooden ceiling and wooden bulkhead wall finishes spanning the interior facing along the south wall. Stained foam insulation was identified on the ceiling at northwest corner and bulkhead along south wall. Elevated moisture content was measured on concrete floor near northwest corner.

Mouldy and water damaged insulation was identified on most of the pipes and pipe fittings in the Beaver/Otter Pump Room. Strong musty odour was noticeable inside and immediately outside the room.



The water damage and mould growth identified on the concrete ceiling above Walk-in Cooler in the Basement of the African Restaurant is likely caused by the leak and/or condensation/moisture from the refrigeration and freezer units present above on the Main Floor. The cause of the water damage in the staff room ceiling space and Drinking Fountain area in the Basement of the African Restaurant could not be identified. The likely cause of water damage and mould growth identified in the Otter Viewing Area is ongoing roof leaks in the Otter Viewing Area. The water damage and mould growth identified on pipe insulations in the Beaver/Otter Pump Room is likely caused by condensation of the pipes and/or spray from the pumps and elevated humidity in the room. Further investigation of water damage and necessary repairs in these areas is recommended. Pinchin's Building Science Group would be pleased to assist with this work, if required.

As per the lab results, insulation on the pipe fittings in the Africa Restaurant and Beaver/Otter Pump Room contain asbestos. Based on the age of the building (1970), the drywall joint compound on the drywall ceiling of Staff Room, skim coat on concrete ceiling and ceiling tiles in the Africa Restaurant should be considered asbestos-containing until proven otherwise by sampling.

The spot measurements of relative humidity in the assessed areas ranged from 17 to 50.2 %RH. The outdoor relative humidity averaged 68 %RH. Authorities recommend that long-term interior relative humidity be maintained below 80 %RH at all locations to avoid mould growth.

4.2 Mould Remediation and Inspection

Mould growth in buildings can be a risk factor for adverse health effects.⁷ The mould growth found in this investigation should be remediated as soon as possible following currently accepted procedures. Pinchin recommends that mould remediation follow the procedures set by the Canadian Construction Association (CCA).⁸ The work should be performed by a contractor with appropriate training, experience and insurance coverage. Ensure that remaining building materials are dry prior to reinstating mould-susceptible finishes, to prevent future mould growth.

Pinchin would be pleased to provide project management services to develop a remediation work plan and retain a specialized environmental abatement contractor. Pinchin could conduct a competitive bidding process to achieve the lowest possible price for the work. Proceeding in this manner will relieve the Client from taking on regulatory responsibility for contractor health and safety, and will reduce the risk of poor contractor performance and possible cross-contamination. Pinchin recommends that the Client retain services for project management, as well as for inspection and testing of this project. Health Canada and

⁷ US Environmental Protection Agency: *Mold Remediation in Schools and Commercial Buildings*. US EPA, 2001.

⁸ Environmental Abatement Council of Ontario: *Mould Abatement Guidelines*. Toronto, ON: EACO, 2004 (revised 2015).



other authorities recommend independent inspection of medium and large scale mould remediation, to protect the occupants and building from cross-contamination.

The presence of asbestos in building materials impacted by the remediation necessitates the use of the precautions required by provincial regulation, in addition to the precautions required for the mould remediation.

4.3 Communication and Interim Risk Management

The findings of this report should be communicated to the occupants as recommended by current mould guidelines, and in workplaces, as mandated by occupational health and safety legislation. The Client should consider any interim risk management actions that would be appropriate under the circumstances, until the mould growth can be remediated. Interim risk management might include isolating an area of the building, or relocating persons experiencing adverse health effects or with greater sensitivity to mould.

5.0 RECOMMENDATIONS

Pinchin offers the following recommendations to improve air quality in this building and address any mould growth or other microbial contamination found. Pinchin would be pleased to assist with further investigations indicated by this investigation, make recommendations for remediation contractors, and provide services for the planning and inspection of the recommended remediation work.

1. Communicate the findings of this report as necessary.
2. Retain a building science professional to perform further investigation into the source of the water damage and make repairs as required. Pinchin's Building Science Group would be pleased to assist with this work, if required.
3. Arrange for the preparation of a detailed Scope of Work for the mould remediation including any required asbestos precautions and finalize an inspection and oversight plan.
4. Perform the following in the Basement of African Restaurant as outlined on drawing 1:
 - a. Following EACO Level 2 mould procedures in conjunction with O.Reg 278/05 Type 2 asbestos procedures clean mould growth on the concrete ceiling above the Walk-in Cooler.
 - b. Following EACO Level 2 mould procedures in conjunction with O.Reg 278/05 Type 2 asbestos procedures remove and dispose of mouldy/water damaged drywall ceiling in the Staff Room one foot past any mouldy and /or water damaged conditions.



- c. Following Level 2 mould procedures in conjunction with O.Reg 278/05 Type 2 asbestos glove bag procedures remove and dispose of mouldy and water damaged pipe insulation in the Drinking Fountain area and in the ceiling space of the Staff Room.
- d. Following EACO Level 1 mould procedures in conjunction with O.Reg 278/05 Type 1 asbestos procedures remove and dispose of mouldy/water damaged/wet ceiling in the Staff Room and Office Space.
5. Following Level 2 mould procedures perform the following in the Otter Viewing Area as outlined in drawing 3:
 - a. Clean mould growth with wire brush on the wood ceiling and wall finishes. Dispose of uncleanable part of the ceiling and wall finishes.
 - b. Remove and dispose of stained foam insulation on the ceiling northwest corner and bulkhead along south wall.
6. Following Level 2 mould procedures in conjunction with Type 3 asbestos procedures remove and dispose of mouldy and water damaged insulation on the pipes and pipe fittings in the Beaver/ Otter Pump Room as outlined on drawing 2.
7. Finalize an inspection and testing plan to document the mould remediation. To confirm, Pinchin will perform inspections at the following stages:
 - a. Clean Site Preparation
 - b. Post-Remediation Inspection
 - c. Post-Remediation Air Sampling
8. Clean the floors, other building surfaces, furnishings and contents in areas immediately adjacent to the remediation work area(s), following normal custodial practices.
9. Implement drying procedures as necessary. Ensure all surfaces are dry before installation of new finishes.

6.0 TERMS AND LIMITATIONS

This work was performed subject to the Terms and Limitations presented or referenced in the proposal for this project.

Information provided by Pinchin is intended for Client use only. Pinchin will not provide results or information to any party unless disclosure by Pinchin is required by law. Any use by a third party of reports or documents authored by Pinchin or any reliance by a third party on or decisions made by a third party based on the findings described in said documents, is the sole responsibility of such third parties.



Investigation of Mould Growth

Toronto Zoo, 361A Old Finch Avenue, Toronto, Ontario
Toronto Zoo

February 19, 2021

Pinchin File: 287332

Pinchin accepts no responsibility for damages suffered by any third party as a result of decisions made or actions conducted. No other warranties are implied or expressed.







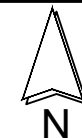



J:\287000s\0287332.000 TORZOO,2000Meadowvale,Tor,IEQ,MLD\Deliverables\Mould Report\287332 Mould Report, 361A Old Finch Ave Toronto, TorZoo, February 19, 2021.docx

Template: Master Mould Investigation Report, IEQ, February 5, 2021

APPENDIX I
Drawing



LEGEND

-  ASBESTOS BULK SAMPLE
-  LEAD BULK SAMPLE
-  MOULD BULK SAMPLE
-  TAPE LIFT SAMPLE
-  WET/WATER STAINED CEILING TILE
-  MISSING CEILING TILE
-  STAINED PLASTIC PIPE
-  MOULDY PIPE INSULATION
-  MOULDY DRYWALL CEILING AND PIPE INSULATION
-  WET AND MOULDY CONCRETE CEILING

NOT ALL KNOWN OR SUSPECTED ASBESTOS-CONTAINING BUILDING MATERIALS MAY BE DEPICTED ON THE DRAWING. REFER TO THE ASBESTOS ASSESSMENT REPORT FOR A COMPLETE LIST OF KNOWN AND SUSPECTED ASBESTOS-CONTAINING BUILDING MATERIALS.

LEGEND IS COLOUR DEPENDENT. NON-COLOUR COPIES MAY ALTER INTERPRETATION.



PROJECT NAME:

MOULD INVESTIGATION

CLIENT NAME:

TORONTO ZOO

PROJECT LOCATION:

361A OLD FINCH AVENUE
TORONTO, ONTARIO

FIGURE NAME:

AFRICAN RESTAURANT
BASEMENT

PROJECT NUMBER: 287332.000 SCALE: NOT TO SCALE

DRAWN BY: JH REVIEWED BY: EK

DATE: FEBRUARY 2021 FIGURE NUMBER: 1 OF 3

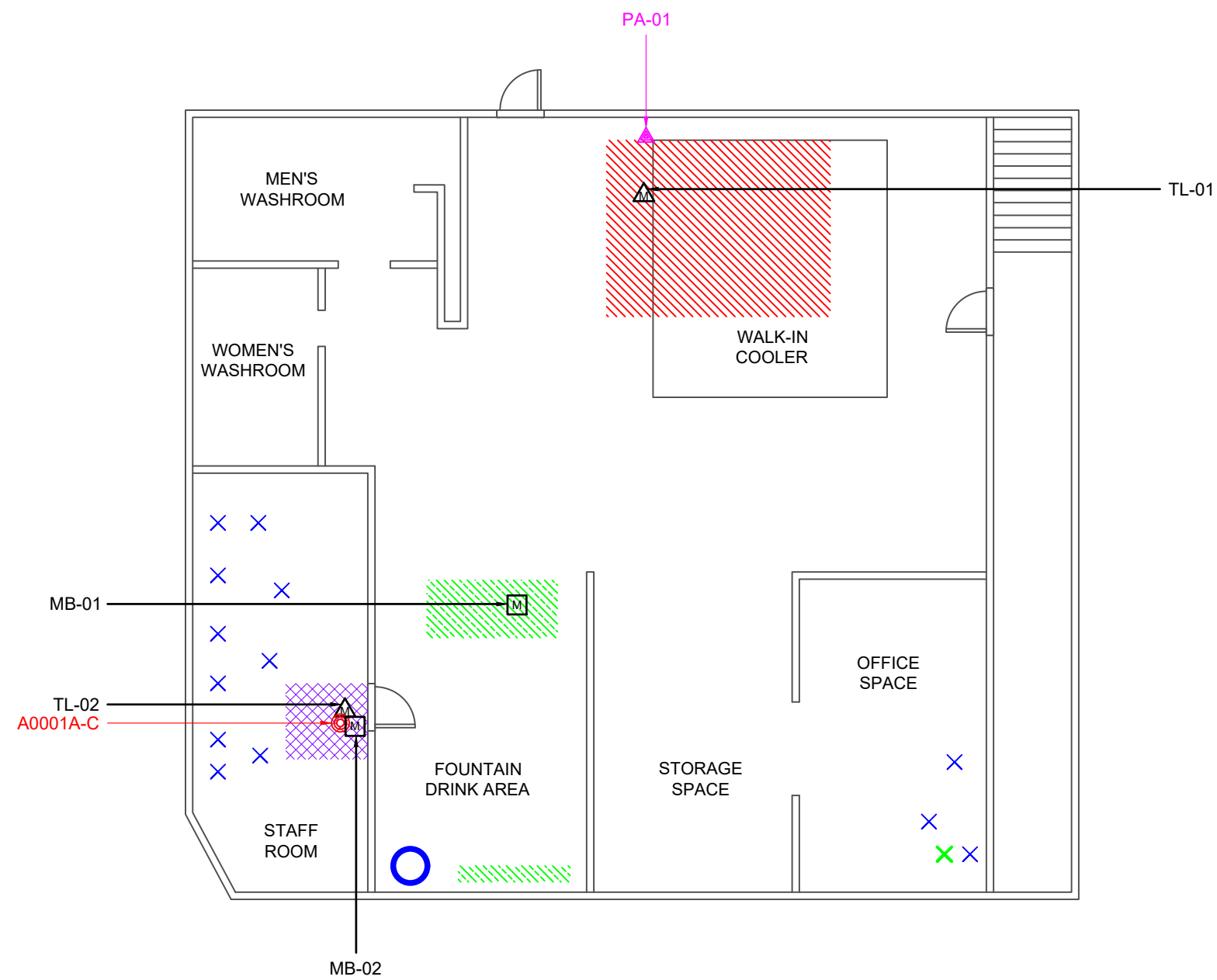

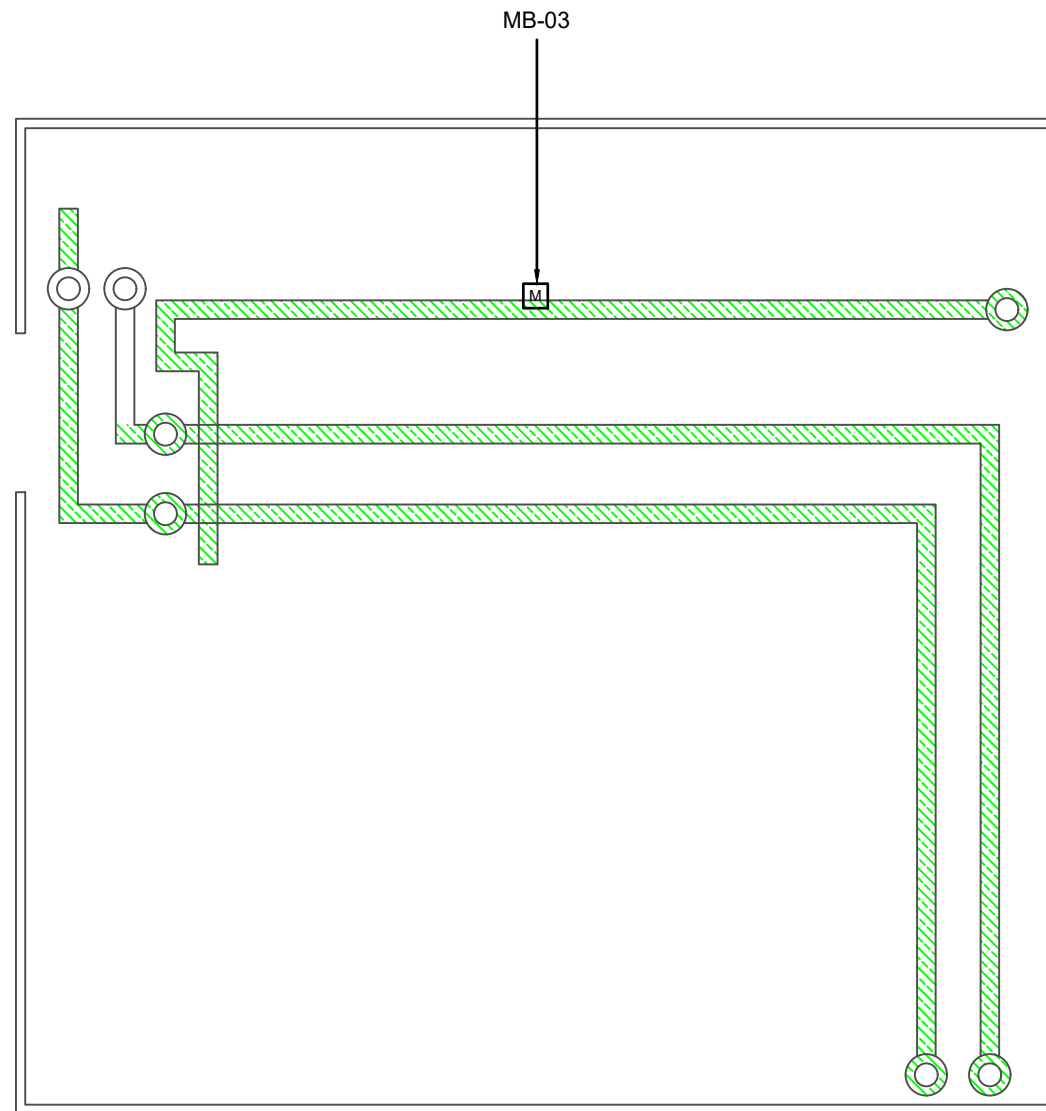

- LEGEND**
- M MOULD BULK SAMPLE
 - MOULDY PIPE INSULATION

LEGEND IS COLOUR DEPENDENT.
NON-COLOUR COPIES MAY ALTER
INTERPRETATION.



PROJECT NAME:
MOULD INVESTIGATION

CLIENT NAME:
TORONTO ZOO

PROJECT LOCATION:
361A OLD FINCH AVENUE
TORONTO, ONTARIO

FIGURE NAME:
OTTER PUMP ROOM



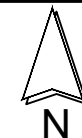

PROJECT NUMBER: 287332.000	SCALE: NOT TO SCALE
-------------------------------	------------------------

DRAWN BY: JH	REVIEWED BY: EK
-----------------	--------------------

DATE: FEBRUARY 2021	FIGURE NUMBER: 2 OF 3
------------------------	--------------------------



LEGEND

-  TAPE LIFT SAMPLE
-  UPPER WATER STAINED WOODEN WALL FINISHES
-  ELEVATED MOISTURE ON CONCRETE SLAB
-  STAINED FOAM INSULATION
-  WATER STAINED WOODEN CEILING FINISHES

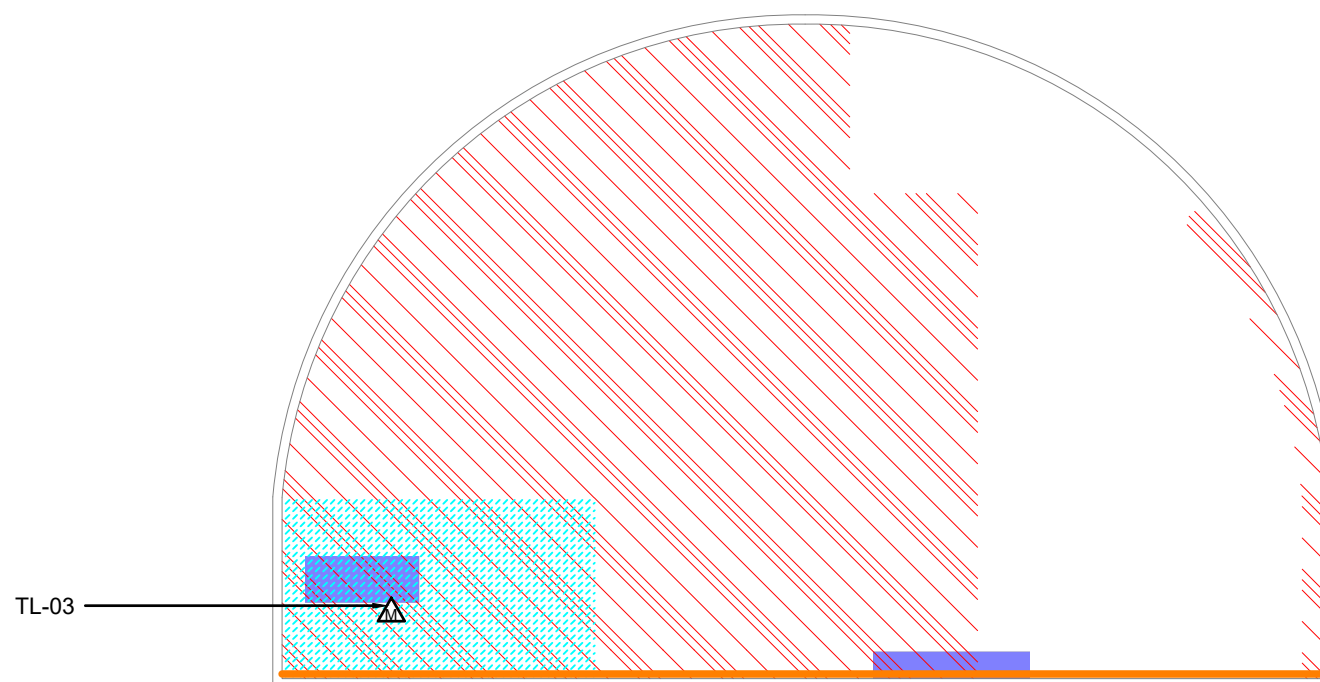

LEGEND IS COLOUR DEPENDENT.
NON-COLOUR COPIES MAY ALTER
INTERPRETATION.



PROJECT NAME:

MOULD INVESTIGATION

CLIENT NAME:

TORONTO ZOO

PROJECT LOCATION:

361A OLD FINCH AVENUE
TORONTO, ONTARIO

FIGURE NAME:

OTTER VIEWING AREA

PROJECT NUMBER:
287332.000

SCALE:
NOT TO SCALE

DRAWN BY:
JH

REVIEWED BY:
EK

DATE:
FEBRUARY 2021

FIGURE NUMBER:
3 OF 3

APPENDIX II
Results of Mould Samples



2470 Milltower Court
Mississauga, ON L5N 7W5
Tel: (905) 363-0678
Fax: (905) 363-0681



Laboratoire d'analyse
accrédité par le
gouvernement du Québec



Pinchin Environmental Microbiology Laboratory *Certificate of Analysis*

CUSTOMER: Elizabeth Kennedy, Doug Hawkins, Mughis Syed

COMPANY: Pinchin Ltd.

ADDRESS: 2470 Milltower Crt.
Mississauga, ON L5N 7W5

PROJECT NAME: TORZOO, 2000 Meadowvale, Tor, IEQ, MLD

PROJECT NO.: 287332

LAB REFERENCE NO.: m245451

TYPE OF SAMPLE(S): BULK, TAPE-LIFT

SAMPLE CONDITION: Acceptable

DATE COLLECTED: February 8, 2021

DATE RECEIVED: February 10, 2021

DATE ANALYSED: February 10, 2021

DATE REPORTED: February 10, 2021

ANALYST: Lubov Beliakov, CMS (PhD)

TITLE: Environmental Microbiologist

REVIEWER: Rawah Naeem, M.Sc.

TITLE: Environmental Microbiologist

Method of Analysis: Analysis of Bulk and Tape-lift Samples by Direct Microscope Examination (SOP: DME-BLK, Rev. 9, December 18, 2019)

This SOP is based on methods described in: "AIHA's Field Guide for Determination of Biological Contaminants in Environmental Samples", "Samson et al's Food and Indoor Fungi", and the "IRRST method 360". Bulk samples are scanned under a stereomicroscope for the presence of mould growth; cellotape samples taken from these are mounted on glass slides and examined under light microscope at X400, X600 (630) or X1000 magnifications as appropriate. Moulds are identified to the genus using keys in relevant books and literature. Mould growth is assessed as Heavy, Moderate or Slight by examining the mycelium cover on the sample and/or the slide preparations. Some moulds may be difficult to identify from bulk samples and these are reported as "Unidentified mould". Spores observed in the absence of an established mycelium are identified whenever possible and rated as "few" for 5-50 spores or "masses" for >50 spores. Results are not corrected for blanks. Estimation of uncertainty is provided upon request.

COMMENTS/OBSERVATIONS (IF ANY):

- Notes:**
1. The result(s) relate only to the sample(s) tested.
 2. This test report shall not be reproduced except in full, without written approval of the laboratory.
 3. Services are subject to Pinchin Ltd. Standard Terms and Conditions for Laboratory Services.



2470 Milltower Court
 Mississauga, ON L5N 7W5
 Tel: (905) 363-0678
 Fax: (905) 363-0681



Laboratoire d'analyse
 accrédité par le
 gouvernement du Québec



Pinchin Environmental Microbiology Laboratory Certificate of Analysis

CUSTOMER: Elizabeth Kennedy, Doug Hawkins, Mughis Syed

PROJECT NAME: TORZOO, 2000 Meadowvale, Tor, IEQ, MLD

LAB REFERENCE NO: m245451

PROJECT NO.: 287332

DATE ANALYSED: February 10, 2021

ANALYST: Lubov Beliakov, CMS (PhD)

RESULTS FOR BULK, TAPE-LIFT DME ANALYSIS

Customer Sample No.	Lab Sample ID.	Description	Mould Identified, in Rank Order	Comments (if any)
MB-01	m245451-1	Pipe insulation – African restaurant basement	<i>Cladosporium</i> sp <i>Ulocladium</i> sp	Heavy growth
MB-02	m245451-2	Drywall paper – African restaurant basement staff room	<i>Cladosporium</i> sp <i>Ulocladium</i> sp	Heavy growth
MB-03	m245451-3	Pipe insulation – beaver / otter pump room	<i>Stachybotrys</i> sp <i>Aspergillus/Penicillium</i> sp (a few spores)	Heavy growth
TL-00	m245451-4	Ceiling above cooler – African restaurant basement	<i>Cladosporium</i> sp	Heavy growth
TL-01	m245451-5	Basement staff room	<i>Cladosporium</i> sp	Heavy growth
TL-02	m245451-6	Wooden finishes in otter viewing area	<i>Cladosporium</i> sp Unidentified mould	Heavy growth

Signature of Analyst:



2470 Milltower Court
Mississauga, ON L5N 7W5
tel: 905.363.0678 fax: 905.363.0681
1.855.PINCHIN www.pinchin.com

M248481

Environmental Microbiology Laboratory

Chain of Custody Form

REPORT RESULTS TO	Contact: Elizabeth Kennedy, Doug Hawkins, Mughis Syed			Dept: MLD	
	Company: Pinchin Ltd			Tel:	Fax:
	Mailing Address: 2470 Milltower Court			Email: ekennedy@pinchin.com , dhawkins@pinchin.com , msyed@pinchin.com	
	City: Mississauga	Prov: ON	Postal Code: L5N7W5	Customer Job / P.O. #: 0287332.000	
Special Instructions:				Project: TORZOO, 2000 Meadowvale, Tor, IEQ, MLD	
Report Language: English <input checked="" type="checkbox"/> French <input type="checkbox"/>		No. Samples Submitted: 7		Invoice To: Mughis Syed	

ANALYSIS TYPES	
1. Total Fungal Particulate (Spore count and Identification)	5. Bacteria (Quantification/Gram staining)
2. Direct Microscope Examination (Fungal)	6. Heterotrophic Plate Counts (HPC)
3. Direct Microscope Examination (Particulate): a. Quantitative b. Qualitative	7. E.coli/Total Coliforms
4. Fungal Quantification & Identification (Andersen/RCS)	8. Other: _____

Sample#	Description	Analysis Requested (e.g. 3a)	Date Sampled	Vol (L) or Area (cm ²)	TAT		FOR LAB USE ONLY LAB #
					REG.	RUSH	
MB-01	Pipe insulation – African Restaurant Basement	2	Feb 8, 2021	N/A		X	M248481-1
MB-02	Drywall Paper – African Restaurant Basement Staff Room	2	Feb 8, 2021	N/A		X	-2
MB-03	Pipe insulation – Beaver / Otter Pump Room	2	Feb 8, 2021	N/A		X	-3
TL-00	Blank	2	Feb 8, 2021	N/A		X	-
TL-01	Ceiling above cooler – African Restaurant Basement	2	Feb 8, 2021	N/A		X	-4
TL-02	Basement Staff Room	2	Feb 8, 2021	N/A		X	-5
TI-03	Wooden Finishes in Otter viewing Area	2	Feb 8, 2021	N/A		X	-6

CHAIN OF CUSTODY	Collected by: Elizabeth Kennedy; Doug Hawkins		FOR LAB USE ONLY:	
	Relinquished by: EK	Date/Time: Feb 9, 2021	Received by: <i>[Signature]</i>	Date/Time: FEB 10 2021 10:10

Authorized by: _____ **Date:** _____

Customer Signature MUST Accompany Request. Customer accepts Pinchin Ltd. Standard Terms and Conditions for Laboratory Services (see over)

Reviewed
2/10/21

APPENDIX III
Results of Asbestos and Lead Samples



Pinchin Ltd. Asbestos Laboratory Certificate of Analysis

Project Name:	TorZoo, 361A Old Finch Avenue	Date Received:	February 10, 2021
Project No.:	0287332.000	Date Analyzed:	February 10, 2021
Prepared For:	E. Kennedy / D. Hawkins / M. Syed	# Samples submitted:	3
Lab Reference No.:	b245442	# Phases analyzed:	1
Analyst(s):	K. Cockburn		

Method of Analysis:

EPA 600/R-93/116 - Method for the Determination of Asbestos in Bulk Building Materials dated July, 1993

Bulk samples are checked visually and scanned under a stereomicroscope. Slides are prepared and observed under a Polarized Light Microscope (PLM) at magnifications of 40X, 100X or 400X as appropriate. Asbestos fibres are identified by a combination of morphology, colour, refractive index, extinction, sign of elongation, birefringence and dispersion staining colours. A visual estimate is made of the percentage of asbestos present. A reported concentration of less than (<) the regulatory threshold indicates the presence of confirmed asbestos in trace quantities, limited to only a few fibres or fibre bundles in an entire sample. This method complies with provincial regulatory requirements where applicable. Multiple phases within a sample are analyzed and reported separately.

All bulk samples submitted to this laboratory for asbestos analysis are retained for a minimum of three months. Samples may be retrieved, upon request, for re-examination at any time during that period.

The Pinchin Ltd. Mississauga asbestos laboratory is accredited by the National Institute of Standards and Technology, National Voluntary Laboratory Accreditation Program (NVLAP Lab Code 101270-0) for the 'EPA – 40 CFR Appendix E to Subpart E of Part 763, Interim Method of the Determination of Asbestos in Bulk Insulation Samples,' and the 'EPA 600/R-93/116: Method for the Determination of Asbestos in Bulk Building Materials'; and meets all requirements of ISO/IEC 17025:2017.

This report relates only to the items tested.

NOTE: *This test report may not be reproduced, except in full, without the written approval of the laboratory. The client may not use this report to claim product endorsement by NVLAP or any agency of the U.S. Government. This report is valid only when signed in blue ink by the analyst. Vinyl asbestos floor tiles contain very fine fibres of asbestos and may be missed by some laboratories using the PLM method. Internal verification studies performed by Pinchin indicate that the chance of missing asbestos in floor tiles is no higher than about 2%. The vinyl tile study and laboratory documentation on measurement uncertainty is available upon request. The analysis of dust samples by PLM cannot be used as an indicator of past or present airborne asbestos fibre levels.*



Pinchin Ltd. Asbestos Laboratory
Certificate of Analysis

Project Name: TorZoo, 361A Old Finch Avenue
Project No.: 0287332.000
Prepared For: E. Kennedy / D. Hawkins / M. Syed

Lab Reference No.: b245442
Date Analyzed: February 10, 2021

BULK SAMPLE ANALYSIS

SAMPLE IDENTIFICATION	SAMPLE DESCRIPTION	% COMPOSITION (VISUAL ESTIMATE)	
		ASBESTOS	OTHER
A0001A Pipe parging cement just inside basement staff room	Homogeneous, grey, soft, parging cement.	Chrysotile 25-50%	Non-Fibrous Material 50-75%
Comments:	Cellulose and man-made vitreous fibres are present on the surface of this sample.		
A0001B Pipe parging cement just inside basement staff room			Not Analyzed
Comments:	Analysis was stopped due to a previous positive result.		
A0001C Pipe parging cement just inside basement staff room			Not Analyzed
Comments:	Analysis was stopped due to a previous positive result.		

Reviewed by:

Digitally signed by
Cheryl Hendsbee
Date: 2021.02.11
10:17:16 -05'00'

Reporting Analyst:

Digitally signed by
Cheryl Hendsbee
Date: 2021.02.11
10:17:04 -05'00'

Requested coc. Received
1:5pm



Analyzed by: *HC*
Reviewed by: *HB*
Report Sent by: *HC*

**Pinchin Ltd. - Asbestos Laboratory
Internal Asbestos Bulk Sample Chain of Custody**

Client Name:	TorZoo			Project Address:	361A Old Finch Avenue		
Portfolio/Building No:				Pinchin File:	287332		
Submitted by:	Elizabeth Kennedy ; Doug Hawkins			Email:	ekennedy@pinchin.com ; dhawkins@pinchin.com		
CC Results to:	Mughis Syed			CC Email:	msyed@pinchinc.com		
Date Submitted:	February	8	2020	Required by:	Month	Day	Year
# of Samples:	3			Priority:	Rush Turnaround		
Year of Building Construction (Mandatory, Years ONLY):							
Do NOT Stop on Positive (Sample Numbers):							
Pinchin Group Company (Mandatory Field):	Pinchin						

To be Completed by Lab Personnel Only:							
Lab Reference #:	0245 442			Time:	24 hour clock		
Received by:	FEB 10 2021 <i>HC</i>			Date:	Month	Day	Year
Name(s) of Analyst(s):	<i>HC</i> 2021/02/10						

Sample Prefix	Sample No.	Sample Suffix	Sample Description/Location (Mandatory)
A	0001	A	Pipe parging cement just inside basement staff room <i>CH 25-501.</i>
A	0001	B	Pipe parging cement just inside basement staff room <i>-NA-</i>
A	0001	C	Pipe parging cement just inside basement staff room <i>-NA-</i>



Analysis for Lead Concentration in Paint Chips

by Flame Atomic Absorption Spectroscopy
EPA SW-846 3050B/6010C/7000B



Customer: Pinchin Ltd.
2470 Milltower Court
Mississauga, ON L5N 7W5

Attn: Elizabeth Kennedy
Doug Hawkins
Mughis Syed

Lab Order ID: 71959641
Analysis ID: 71959641_PBP
Date Received: 2/12/2021
Date Reported: 2/15/2021

Project: Mould & Water Damage Investigation

Sample ID	Description	Mass (g)	Concentration (ppm)	Concentration (% by weight)
Lab Sample ID	Lab Notes			
PA-01	Off-White from Concrete Wall Near Basement Exit Door	0.0573	98	0.0098%
71959641PBP_1				

Unless otherwise noted blank sample correction was not performed on analytical results. Scientific Analytical Institute participates in the AIHA ELPAT program. ELPAT Laboratory ID: 173190. This report relates only to the samples tested and may not be reproduced, except in full, without the written approval of SAI. Analytical uncertainty available upon request. The quality control samples run with the samples in this report have passed all EPA required specifications unless otherwise noted. RL: (Report Limit for an undiluted 50ml sample is 4µg Total Pb). Unless indicated, areas and volumes were provided by the customer.

Athena Summa (1)



Analyst

Scientific Analytical Institute, Inc. 4604 Dundas Dr. Greensboro, NC 27407 (336) 292-3888

Laboratory Director

1191591041

Version 1-15-2012

Client:	Pinchin Ltd.	*Instructions:	<p>Use Column "B" for your contact info</p> <p>To See an Example Click the bottom Example Tab.</p>	<p>Invoice to:</p> <p>Mughis Syed</p> <p>msyed@pinchin.com</p>
Contact:	Elizabeth Kennedy, Doug Hawkins, Mughis Syed			
Address:	2470 Milltower court	<p>Enter samples between "<<" and ">>"</p> <p>Begin Samples with a "<<" above the first sample and end with a ">>" below the last sample.</p> <p>Only Enter your data on the first sheet "Sheet1"</p>	<p>Scientific Analytical Institute</p> 	<p>4604 Dundas Dr.</p> <p>Greensboro, NC 27407</p> <p>Phone: 336.292.3888</p> <p>Fax: 336.292.3313</p> <p>Email: lab@sailab.com</p>
Phone:	905-363-0678			
Fax:	289.971.1663			
Email:	ekennedy@pinchin.com dhawkins@pinchin.com msyed@pinchin.com	<p>Note: Data 1 and Data 2 are optional fields that do not show up on the official report, however they will be included in the electronic data returned to you to facilitate your reintegration of the report data.</p>		<p>4604 Dundas Dr.</p> <p>Greensboro, NC 27407</p> <p>Phone: 336.292.3888</p> <p>Fax: 336.292.3313</p> <p>Email: lab@sailab.com</p>
Project:	Mould & Water damage investigation			
Client Notes:				
P.O. #:	287332			
Date Submitted:	08-02-21 0:00			
Analysis:	Lead			
TurnAroundTime:	Rush			

Sample Number	Data 1 (Lab use only)	Sample Description	Data 2 (Lab use only)
<< PA-01 >>	[Enter data of your choosing here]	Off-white from concrete wall near basement exit door	[Enter data of your choosing here]

Accepted

Rejected

J. J. ... 2-12
10:30A